

SEVILLA

Nadstawka 140

A	B	C		D
1	S48-004	475	396	4/4
2	S48-005	475	396	4/4
3	S48-106	1072	285	1/4
4	S48-107	1072	285	1/4
5	S48-108	493	285	1/4
6	S48-109	493	285	1/4
7	S48-110	160	176	2/4
8	S48-230	1400	310	2/4
9	S48-305	367	285	2/4
10	S48-350	601	179	2/4
11	S48-307	367	260	1/4
12	S48-351	601	285	2/4
13	S48-451	1367	80	2/4
14	S48-950	1394	497	2/4
15	S48-951	1394	583	2/4

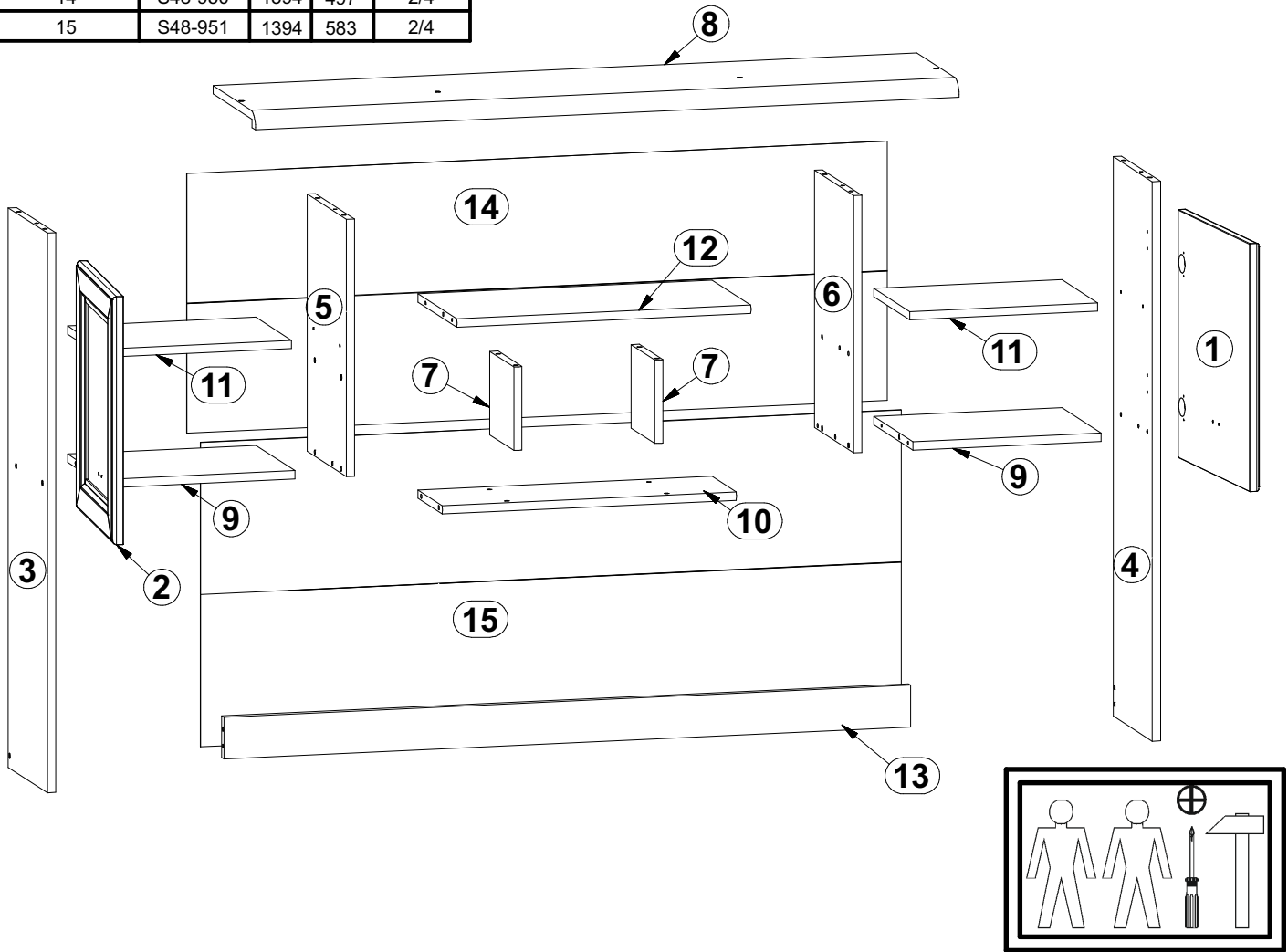
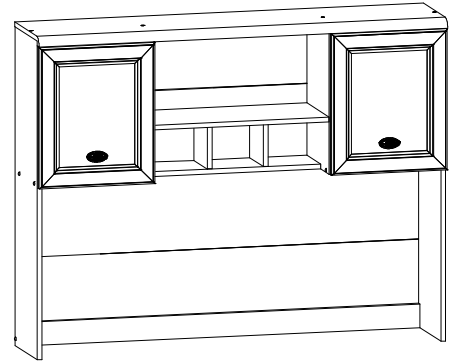

4x a44	4x b19	2x c180 ¹	8x d1 φ5x17 mm	18x e1 φ7x50 mm	8x e2 φ5,3x13 mm	28x f1 φ8x30 mm	4x j83 M4x16 mm	80x l1
2x n52 φ2x12/1mm	6x p25 φ3,5x16 mm	5x p38 φ3,5x16 mm	8x p51 φ3,5x15 mm	12x s1	1x z1	1x n26 ¹	1x p38 φ3,5x16 mm	

1

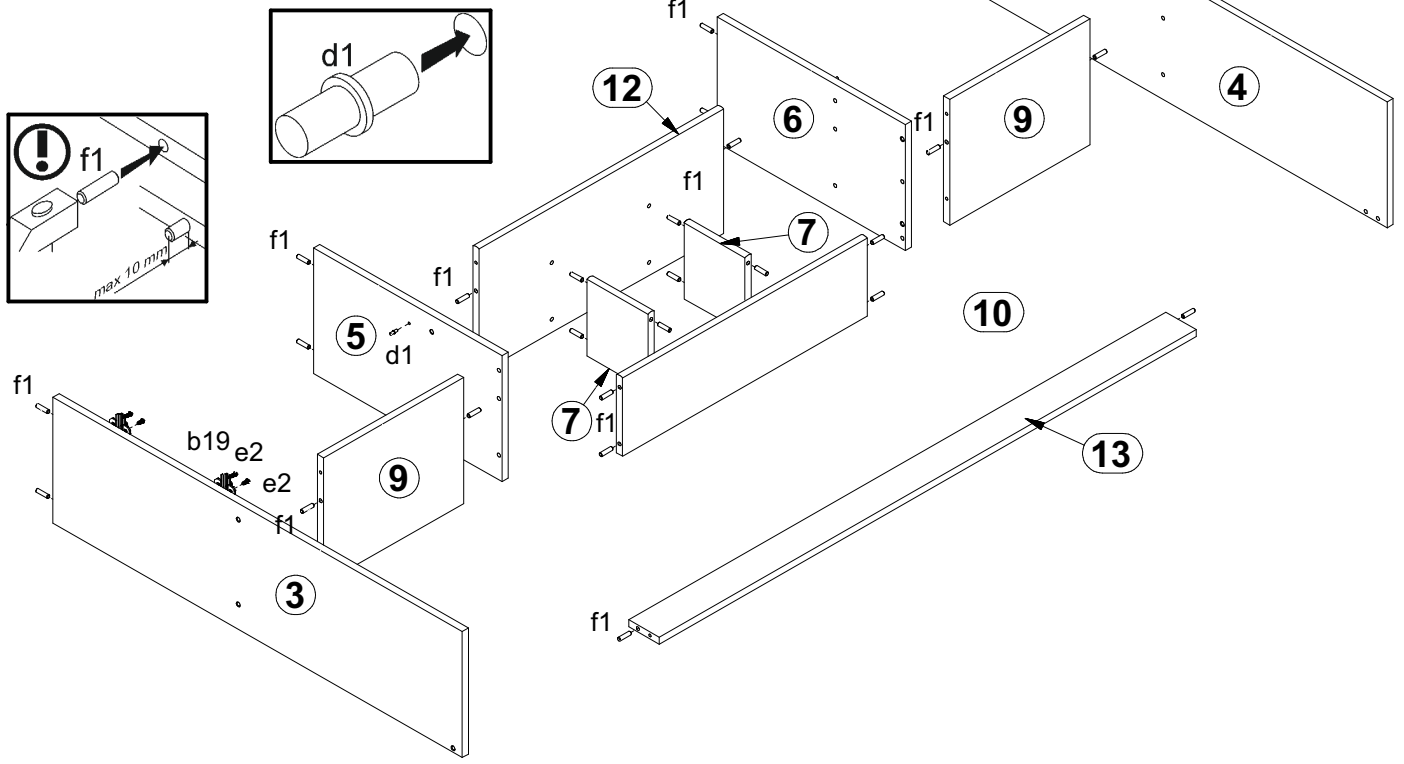
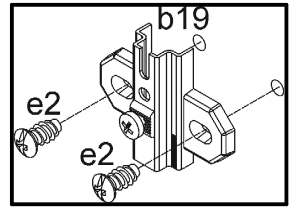

2

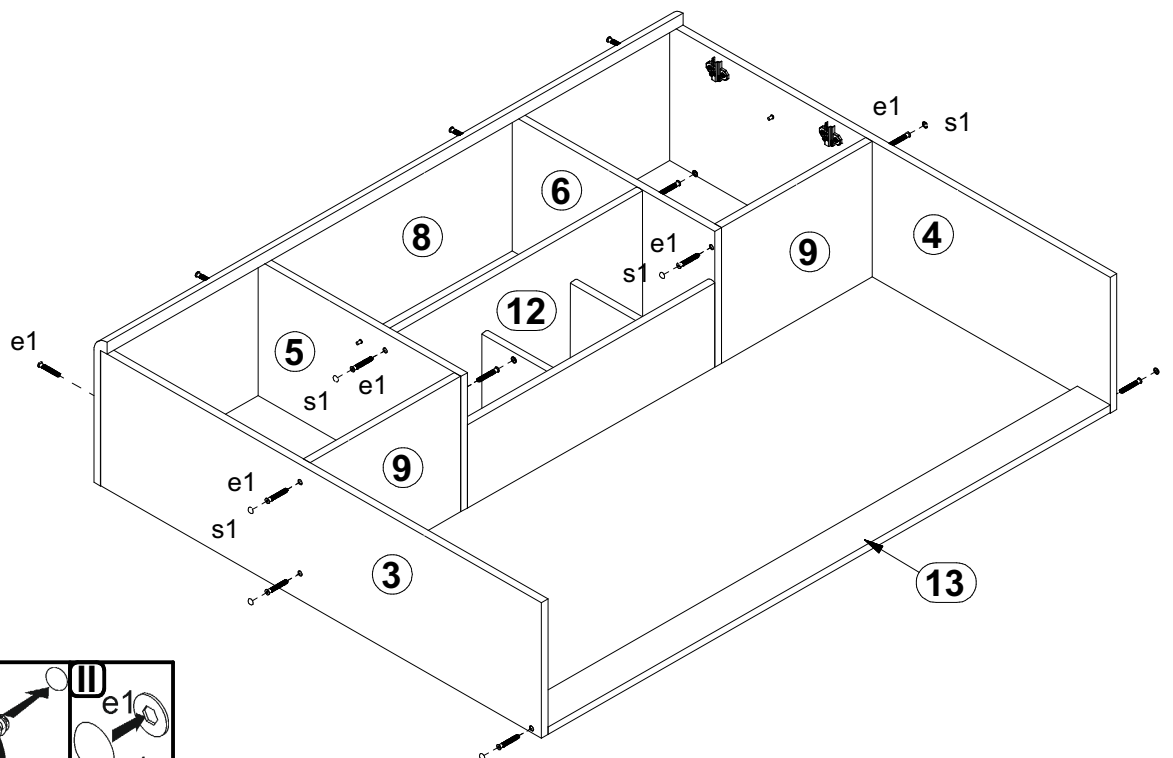

3

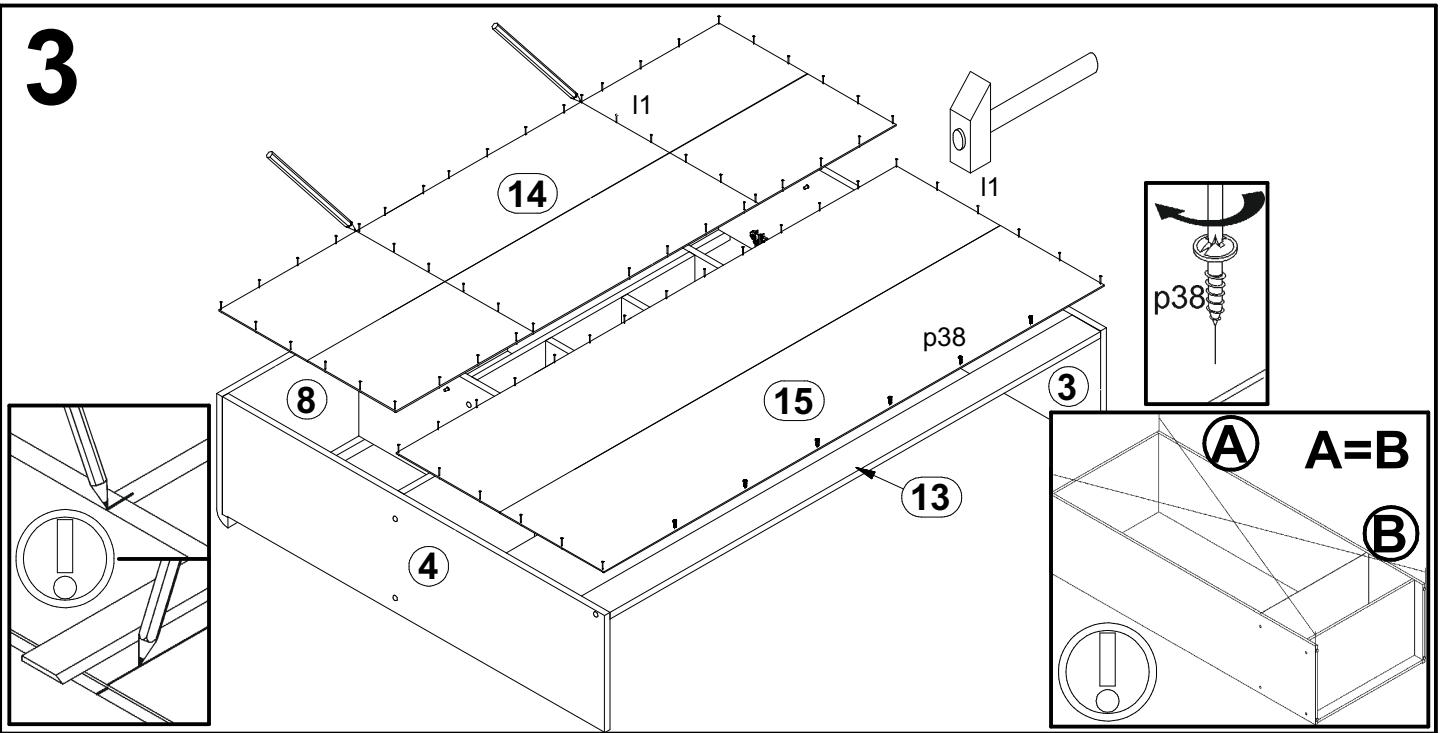

4

